

# Introduction

January 1, 1801, the first day of a new century. In the early morning hours of that day, Giuseppe Piazzi, peering through his telescope in Palermo, discovered an object which appeared as a small dot of light in the dark night sky. (Figure 1.1) He noted its position with respect to the other stars in the sky. On a subsequent night, he saw the same small dot of light, but this time it was in a slightly different position against the familiar background of the stars.

He had not seen this object before, nor were there any recorded observations of it. Over the next several days, Piazzi watched this new object, carefully noting its change in position from night to night. Using the method employed by astronomers since ancient times, he recorded its position as the intersection of two circles on an imaginary sphere, with himself at the center. (Figure 1.2a) (Astronomers call this the “celestial sphere”; the circles are similar to lines of longitude and latitude on Earth.) One set of circles was thought of as running perpendicular to the celestial equator, ascending overhead from the observer’s horizon, and then descending. The other set of circles runs parallel to the celestial equator.

To specify any one of these circles, we require an angu-

lar measurement: the position of a longitudinal circle is specified by the angle (arc) known as the “right ascension,” and that of a circle parallel to the celestial equator, by the “declination.”\* (Figure 1.2b). Hence, two angles suffice to specify the position of any point on the celestial sphere. This, indeed, is how Piazzi communicated his observations to others.

Piazzi was able to record the changing positions of the new object in a total of 19 observations made over the following 42 days. Finally, on February 12, the object disappeared in the glare of the sun, and could no longer be observed. During the whole period, the object’s total motion made an arc of only  $9^\circ$  on the celestial sphere.

What had Piazzi discovered? Was it a planet, a star, a comet, or something else which didn’t have a name? (At first, Piazzi thought he had discovered a small comet with no tail. Later, he and others speculated it was a planet between Mars and Jupiter.) And now that it had disappeared, what was its trajectory? When and where could it

\* Figure 1.1 shows the celestial sphere as seen by an observer, with a grid for measuring right ascension and declination shown mapped against it.

FIGURE 1.2 *The celestial sphere. (a) Since ancient times, astronomers have recorded their observations of heavenly bodies as points on the inside of an imaginary sphere called the celestial sphere, or “sphere of the fixed stars,” with the Earth at its center. Arcs of right ascension and parallels of declination are shown. (b) Locating the position of an object on the celestial sphere by measuring right ascension and declination.*

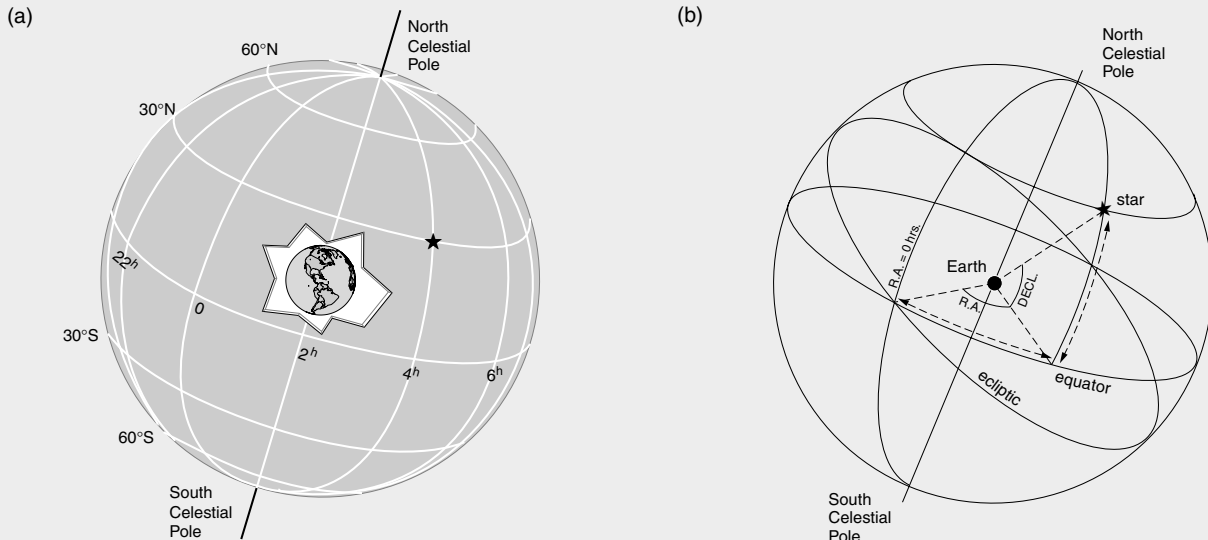
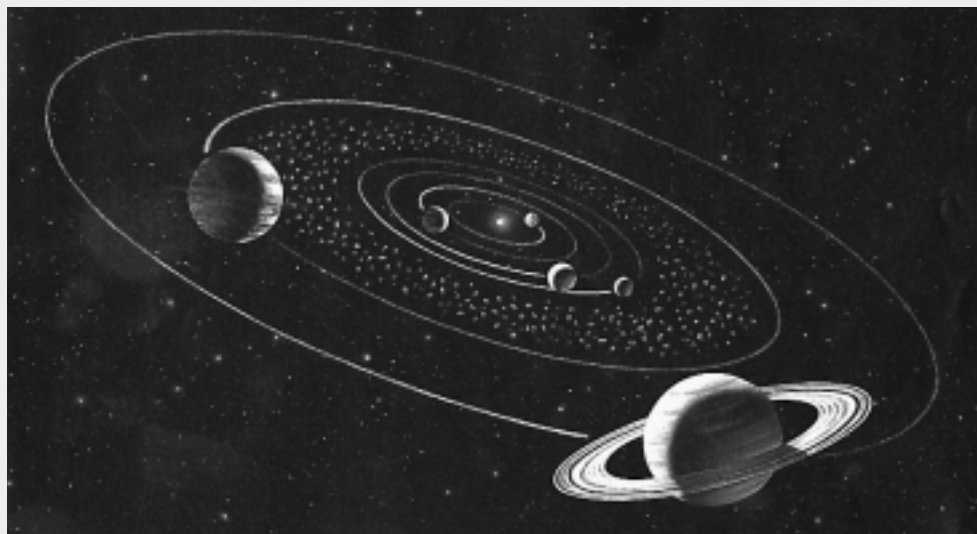

FIGURE 1.3. *Artist's rendering of a "God's eye view" of the first six planets of the solar system. (Note that the correct planetary sizes, and relative distances from the sun of "outer planets" Jupiter and Saturn, are not preserved.)*



be seen again? If it were orbiting the sun, how could its trajectory be determined from these few observations made from the Earth, which itself was moving around the sun?

Had Piazzi observed the object while it was approaching the sun, or was it moving away from the sun? Was it moving away from the Earth or towards it, when these observations were made? Since all the observations appeared only as changes in position against the background of the stars (celestial sphere), what motion did these changes in position reflect? What would these changes in position be, if Piazzi had observed them from the sun? Or, a point outside the solar system itself: a "God's eye view"? (Figure 1.3)

It was six months before Piazzi's observations were published in the leading German-language journal of astronomy, von Zach's *Monthly Correspondence for the Promotion of Knowledge of the Earth and the Heavens*, but news of his discovery had already spread to the leading astronomers of Europe, who searched the sky in vain for the object. Unless an accurate determination of the object's trajectory were made, rediscovery would be unpredictable.

There was no direct precedent to draw upon, to solve this puzzle. The only previous experience that anyone had had in determining the trajectory of a new object in the sky, was the 1781 discovery of the planet Uranus by William Herschel. In that case, astronomers were able to observe the position of Uranus over a considerable time, recording the changes in the position of the planet with respect to the Earth.

With these observations, the mathematicians simply asked, "On what curve is this planet traveling, such that it would produce these particular observations?" If one curve didn't produce the desired mathematical result, another was tried.

As Carl F. Gauss described it in the Preface to his 1809 book, *Theory of the Motion of the Heavenly Bodies Moving about the Sun in Conic Sections*,

As soon as it was ascertained that the motion of the new planet, discovered in 1781, could not be reconciled with the parabolic hypothesis, astronomers undertook to adapt a circular orbit to it, which is a matter of simple and very easy calculation. By a happy accident, the orbit of this planet had but a small eccentricity, in consequence of which, the elements resulting from the circular hypothesis sufficed, at least for an approximation, on which the determination of the elliptic elements could be based.

There was a concurrence of several other very favorable circumstances. For, the slow motion of the planet, and the very small inclination of the orbit to the plane of the ecliptic, not only rendered the calculations much more simple, and allowed the use of special methods not suited to other cases; but they removed the apprehension, lest the planet, lost in the rays of the sun, should subsequently elude the search of observers (an apprehension which some astronomers might have felt, especially if its light had been less brilliant); so that the more accurate determination of the orbit might be safely deferred, until a selection could be made from observations more frequent and more remote, such seemed best fitted for the end in view.

## Linearization in the Small

The false belief that we need a large number of observations, filling out as large an arc as possible, in order to determine the orbit of a heavenly body, is a typical product of the Aristotelean assumptions brought into science by the British-Venetian school of mathematics—the school typified by Paolo Sarpi, Isaac Newton, and Leonhard Euler. Sarpi *et al.* insisted that, if we examine small-

FIGURE 1.4. Nicolaus of Cusa demonstrated, that no matter how many times its sides are multiplied, the polygon can never attain equality with the circle. The polygon and circle are fundamentally different species of figures.

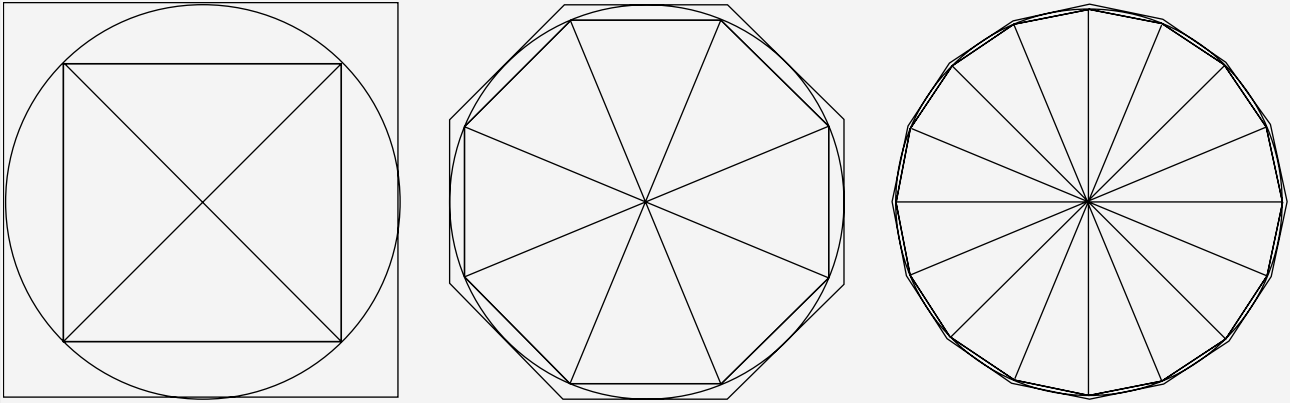

er and smaller portions of any curve in nature, we shall find that those portions look and behave more and more like straight line segments—to the point that, for sufficiently small intervals, the difference becomes practically insignificant and can be ignored. This idea came to be known as “linearization in the small.”

In the mid-Fifteenth century, Nicolaus of Cusa had already demonstrated conclusively that linearization in the small had no place in mathematics—if that mathematics were to reflect truth. Cusa demonstrated that the circle represents a *fundamentally different species of curve* from a straight line, and that this *species difference* does not disappear, or even decrease, when we examine very small portions of the circle. (Figure 1.4) With respect to their increasing number of vertices, the polygons inscribed in and circumscribing the circle become more and more *unlike* it.

Extending Cusa’s discovery to astronomy, Johannes Kepler discovered that the solar system was ordered according to certain harmonic principles. Each small part of the solar system, such as a small interval of a planetary orbit, reflected that same harmonic principle completely. Kepler’s call for the invention of a mathematical concept to measure this self-similarity, provoked G.W. Leibniz to develop the infinitesimal calculus. The entirety of the work of Sarpi, Newton, and Euler, was nothing but a fraud, perpetrated by the Venetian-British oligarchy against the work of Cusa, Kepler, and Leibniz.

Applying the false mathematics of Sarpi *et al.* to astronomy, would mean that the physical Universe became increasingly linear in the small, and that, therefore, the smaller the arc spanned by the given series of observations, the less those observations tell us about the shape of the orbit as a whole. This delusion can be main-

tained, in this case, only if the problem of determining the orbit of an unknown planet is treated as a purely mathematical one.

For example, think of three dots on a plane. (Figure 1.5) On how many different curves could these dots lie? Now add more dots. The more dots, covering a greater part of the curve, the more precise determination of the curve. A small change of the position of the dots, can

FIGURE 1.5. (a) Here are just a few of the curves that can be drawn through the same three points. (b) With more observation points, we may find that the curve is not as anticipated.

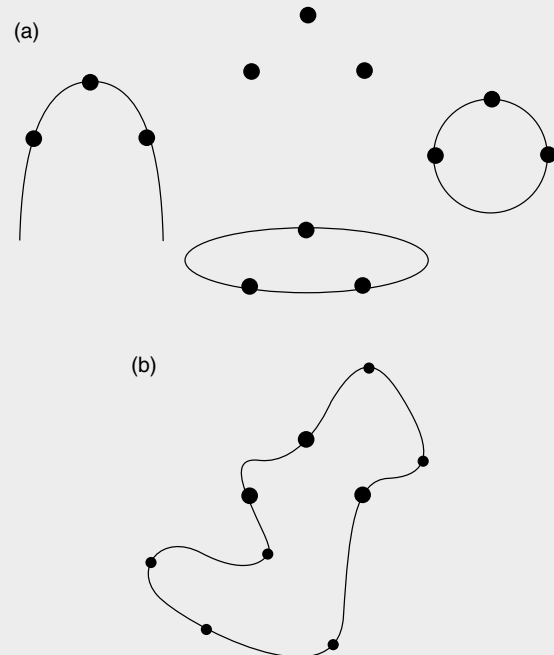

mean a great change in the shape of the curve. The fewer the dots and the closer together they are, the less precise is the mathematical determination of the curve.

If this false mathematics were imposed on the Universe, determining the orbit of a planet would hardly be possible, except by curve-fitting or statistical correlations from as extensive a set of observations as possible. But the changes of observed positions of an object in the night sky, are not dots on a piece of paper. These changes of position are a reflection of physical action, which is self-similar in every interval of that action, in the sense understood by Cusa, Kepler, and Leibniz. The heavenly body is never moving along a straight line, but diverges from a straight line in every interval, no matter how small, in a *characteristic fashion*.

In fact, if we focus on the *characteristic features* of the “non-linearity in the small” of any orbit, then the smaller the interval of action we investigate in this way, the more precise the determination of the orbit as a whole! This key point will become ever clearer as we work through Gauss’ determination of the orbit of Ceres.

It was only an accident that the problem of the determination of the orbit of Uranus could be solved without challenging the falsehood of linearization in the small. But such accidental success of a wrong method, was shattered by the problem presented by Piazzi’s discovery. The Universe was demonstrating Euler was a fool.

(Years later, Gauss would calculate in one hour, the trajectory of a comet, which had taken Euler three days to figure, a labor in which Euler lost the sight of one eye. “I would probably have become blind also,” Gauss said of Euler, “if I had been willing to keep on calculating in this

FIGURE 1.6. *Generation of the conic sections by cutting a cone with a rotating plane. When the plane is parallel to the base, the section is a circle. As the plane begins to rotate, elliptical sections are generated, until the plane parallel to the side of the cone generates a parabola. Further rotation generates hyperbolas.*

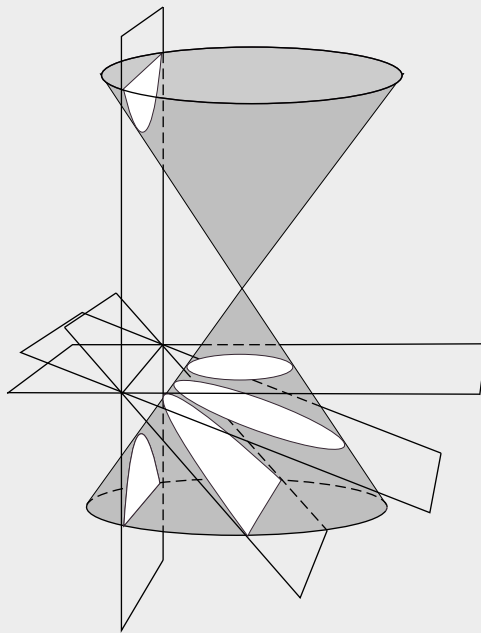

manner for three days!”)

It was September of 1801, before Piazzi’s observations reached the 24-year-old Gauss, but Gauss had already anticipated the problem, and ridiculed other mathematicians for not considering it, “since it assuredly commend-

FIGURE 1.7. *Some characteristic properties of the ellipse (a fuller description is presented in the Appendix).*

(a)  
Every ellipse has two foci  $f, f'$ , such that the sum of distances  $d$  and  $d'$  to any point  $q$  on the circumference of the ellipse is a constant.

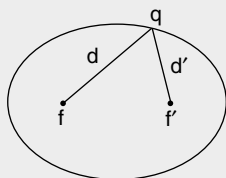

(b)  
The ellipse as a “contraction” of the circumscribed circle, in the direction perpendicular to the major axis. The ratio  $pq : pq'$  remains the same, no matter where  $p$  lies on the major axis.

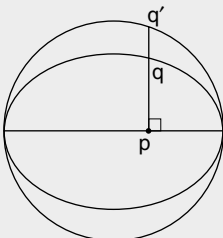

(c)  
Construction of a tangent to the ellipse: Draw a circle around focus  $f$ , with radius equal to the constant distance  $d + d'$ . The tangent at any point  $q$  is the line obtained by “folding” the circle such that point  $q'$  touches the second focus  $f'$ . This construction can be “inverted” to generate ellipses and other conic sections as “envelopes” of straight lines (see text and Figure 1.9).

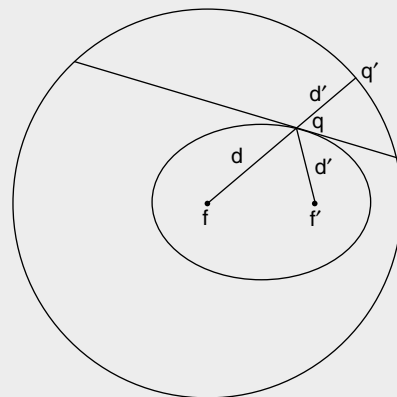

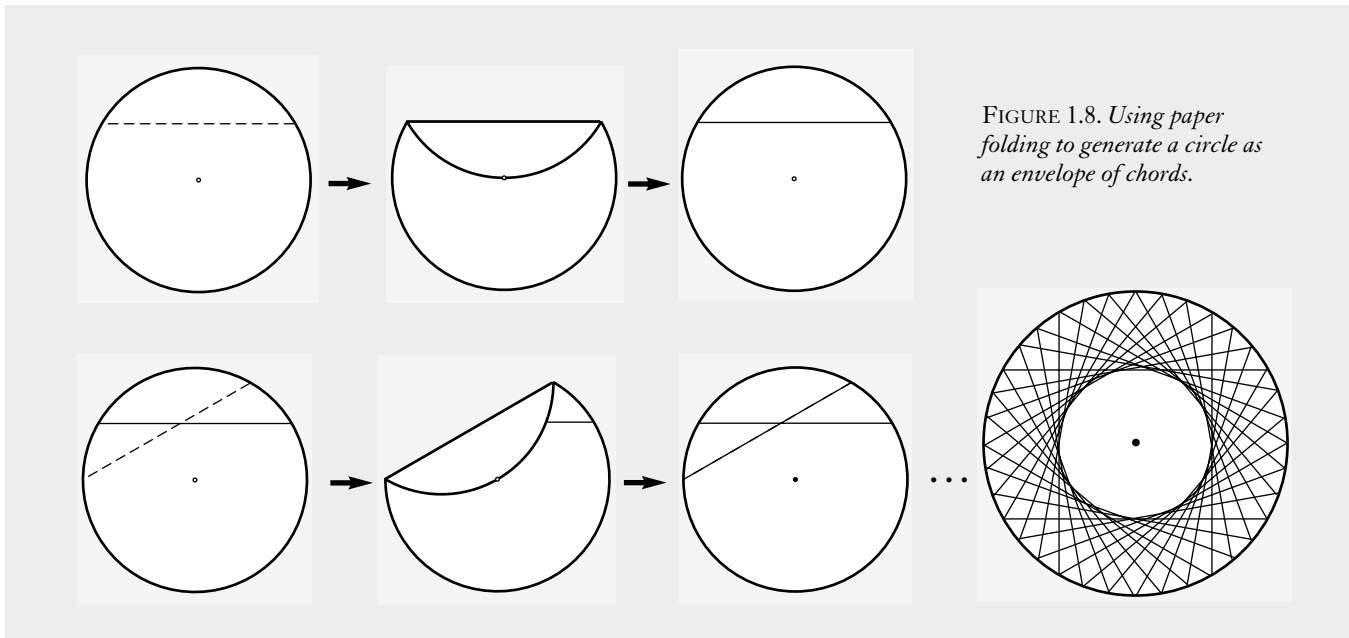

ed itself to mathematicians by its difficulty and elegance, even if its great utility in practice were not apparent.” Because others assumed this problem was unsolvable, and were deluded by the accidental success of the wrong method, they refused to believe that circumstances would arise necessitating its solution. Gauss, on the other hand, considered the solution, before the necessity presented itself, knowing, based on his study of Kepler and Leibniz, that such a necessity would certainly arise.

## Introducing the Conic Sections

Before embarking on our journey to re-discover the method by which Gauss determined the orbit of Ceres, we suggest the reader investigate for himself certain simple characteristics of curves that are relevant to the following chapters. As we shall show later, Kepler discovered that

the planets known to him moved around the sun in orbits in the shape of ellipses. By Gauss’s time, objects such as comets had been observed to move in orbits whose shape was that of other, related curves. All these related curves can be generated by slicing a cone at different angles, and are therefore called “conic sections.” (Figure 1.6)

The conic sections can be constructed in a variety of different ways. (SEE Figure 1.7, as well as the Appendix, “The Harmonic Relationships in an Ellipse”) The reader can get a preliminary sense of some of the geometrical properties of the conic sections, by carrying out the following construction.

Take a piece of waxed paper and draw a circle on it. (Figure 1.8) Then put a dot at the center of the circle. Now fold the circumference onto the point at the center and make a crease. Unfold the paper and make a new fold, bringing another point on the circumference to the point

FIGURE 1.9. Conic sections generated as envelopes of straight lines, using the “waxed paper folding” method. (a) Ellipse. (b) Hyperbola. (c) Parabola.

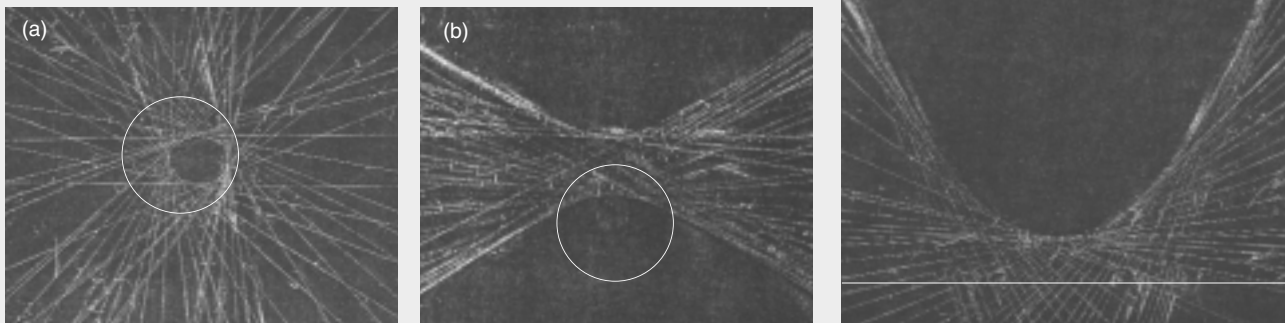
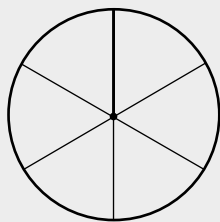
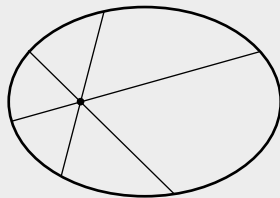

FIGURE 1.10. *The length of a line drawn from the focus to the curve changes as it moves around the curve, except in the case of the circle. In the case of a planetary orbit, that length is the distance from the sun to the planet. Note that the circle and ellipse are closed figures, whereas the parabola and two-part hyperbola are unbounded.*



Circle



Ellipse

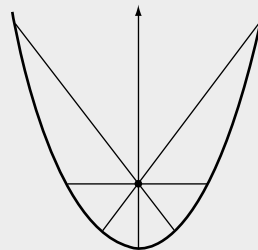

Parabola

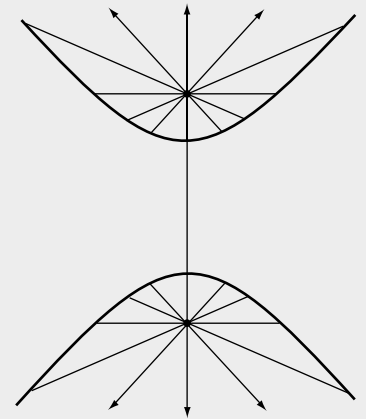

Hyperbola

at the center. Make another crease. Repeat this process around the entire circumference (approximately 25 times). At the end of this process, you will see a circle enveloped by the creases in the wax paper.

Now take another piece of wax paper and do the same thing, but this time put the point a little away from the center. At the end of this process, the creases will envelop an ellipse, with the dot being one focus. (Figure 1.9a)

Repeat this construction several times, each time moving the point a little farther away from the center of the circle. Then try it with the point outside the circle; this will generate a hyperbola. (Figure 1.9b) Then make the same construction, using a line and a point, to construct a

parabola. (Figure 1.9c)

In this way, you can construct all the conic sections as envelopes of lines. Now, think of the different curvatures involved in each conic section, and the relationship of that curvature to the position of the dot (focus).

To see this more clearly, do the following. In each of the constructions, draw a straight line from the focus to the curve. (Figure 1.10) How does the length of this line change, as it rotates around the focus? How is this change different in each curve?

Over the next several chapters, we will discover how these geometrical relationships reflect the harmonic ordering of the Universe.

—Bruce Director

## CHAPTER 2

# Clues from Kepler

What did Gauss do, which other astronomers and mathematicians of his time did not, and which led those others to make wildly erroneous forecasts on the path of the new planet? Perhaps we shall have to consult Gauss's great teacher, Johannes Kepler, to give us some clues to this mystery.

Gauss first of all adopted Kepler's crucial hypothesis, that the *motion of a celestial object is determined solely by its orbit*, according to the intelligible principles Kepler demonstrated to govern all known motions in the solar system. In the Keplerian determination of orbital motion, no information is required concerning mass, velocity, or any other details of the orbiting object itself. Moreover, as Gauss demonstrated, and as we shall rediscover for our-

selves, the orbit and the orbital motion in its totality, can be adduced from nothing more than the internal "curvature" of any portion of the orbit, however small.

Think this over carefully. Here, the science of Kepler, Gauss, and Riemann distinguishes itself *absolutely* from that of Galileo, Newton, Laplace, *et al.* Orbits and changes of orbit (which in turn are subsumed by higher-order orbits) are *ontologically primary*. The relation of the Keplerian orbit, as a relatively "timeless" existence, to the array of successive positions of the orbiting body, is like that of an hypothesis to its array of theorems. From this standpoint, we can say it is the orbit which "moves" the planet, not the planet which creates the orbit by its motion!

FIGURE 2.1. A set of three angles is used to specify the spatial orientation of a given Keplerian orbit relative to the orbit of the Earth. (1) Angle of inclination  $i$ , which the plane of the given orbit makes with the ecliptic plane (the plane of the Earth's orbit). (2) Angle  $\phi$ , which the orbit's major axis makes with the "line of nodes" (the line of intersection of the plane of the given orbit and the ecliptic plane). (3) Angle  $\vartheta$ , which the line of nodes makes with some fixed axis  $\gamma$  in the ecliptic plane (the latter is generally taken to be the direction of the "vernal equinox").

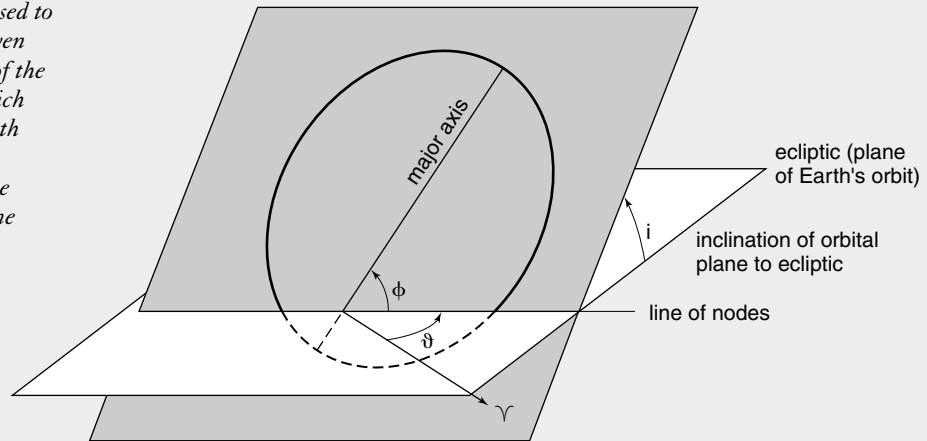

If we interfere with the motion of an orbiting object, then we are doing work against the orbit as a whole. The result is to change the orbit; and this, in turn, causes the change in the visible motion of the object, which we ascribe to our efforts. That, and not the bestial “pushing and pulling” of Sarpian-Newtonian point-mass physics, is the way our Universe works. Any competent astronaut, in order to successfully pilot a rendezvous in space, must have a sensuous grasp of these matters. Gauss’s entire method rests upon it.

Gauss adopted an additional, secondary hypothesis, likewise derived from Kepler, for which we have been prepared by Chapter 1: At least to a *very high degree of precision*, the orbit of any object which does not pass extremely close to some other body in our solar system (moons are excluded, for example), has the form of a simple conic section (a circle, an ellipse, a parabola, or a hyperbola) with focal point at the center of the sun. Under such conditions, the motion of the celestial object is *entirely determined* by a set of five parameters, known among astronomers as the “elements of the orbit,” which specify the form and position of the orbit in space. Once the “elements” of an orbit are specified, and *for as long as the object remains in the specified orbit*, its motion is entirely determined *for all past, present, and future times!*

Gauss demonstrated how the “elements” of any orbit, and thereby the orbital motion itself in its totality, can be adduced from nothing more than the curvature of any “arbitrarily small” portion of the orbit; and how the latter can in turn be adduced—in an eminently practical way—from the “intervals,” defined by only three good, closely spaced observations of apparent positions as seen from the Earth!

## The ‘Elements’ of an Orbit

The *elements* of a Keplerian elliptical orbit consist of the following:

- Two parameters, determining the position of the *plane of the object’s orbit* relative to the plane of the Earth’s orbit (called the “ecliptic”). (**Figure 2.1**) Since the sun is the common focal point of both orbits, the two orbital planes intersect in a line, called the “*line of nodes*.” The relative position of the two planes is uniquely determined, once we prescribe:

- (i) their angle of inclination to each other (i.e., the angle between the planes); and

- (ii) the angle made by the line of nodes with some fixed axis in the plane of the Earth’s orbit.

- Two parameters, specifying the *shape* and *overall scale* of the object’s Keplerian orbit. (**Figure 2.2**) It is not necessary to go into this in detail now, but the chiefly employed parameters are:

- (iii) the relative scale of the orbit, as specified (for example) by its width when cut perpendicular to its major axis through the focus (i.e., center of the sun);

- (iv) a measure of shape known as the “eccentricity,” which we shall examine later, but whose value is 0 for circular orbits, between 0 and 1 for elliptical orbits, exactly 1 for parabolic orbits, and greater than 1 for hyperbolic orbits. Instead of the eccentricity, one can also use the perihelial distance, i.e., the shortest distance from the orbit to the center of the sun, or its ratio to the width parameter;

- Lastly, we have:

- (v) one parameter specifying the angle which the main axis of the object’s orbit within its own orbital plane, makes with the line of intersection with the Earth’s orbit (“line of nodes”). For this purpose, we can

FIGURE 2.2. (a) The relative scale of the orbit can be measured by the line perpendicular to the line of apsides, drawn through the focus (sun). This line is known as the “parameter” of the orbit. (b) The eccentricity is measured as the ratio of the distance  $f$  from the focus to the center of the orbit (point  $c$ , the midpoint of the major axis) divided by the semi-major axis  $A$ . For the circle, in which case the focus and center coincide,  $f = 0$ ; for the ellipse,  $0 < f/A < 1$ .

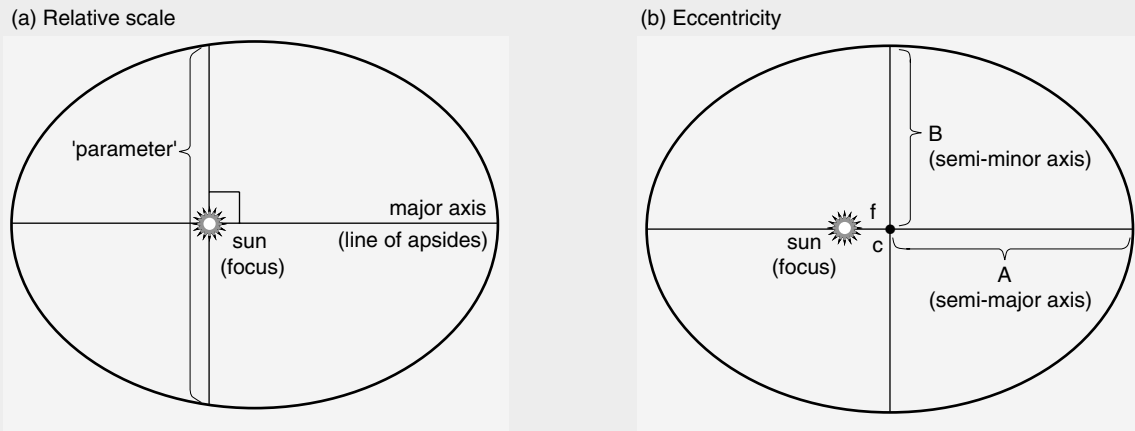

take the angle between the major axis of the object’s orbit and the line of nodes. (Figure 2.1)

The entire motion of the orbiting body is determined by these elements of the orbit alone. If you have mastered Kepler’s principles, you can compute the object’s precise position at any future or past time. All that you must know, in addition to Kepler’s laws and the five parameters just described, is a single time when the planet was (or will be) in some particular locus in the orbit, such as the perihelion position. (Sometimes, astronomers include the time of last perihelion-crossing among the “elements.”)

Now, let us go back to Fall 1801, as Gauss pondered over the problem of how to determine the orbit of the unknown object observed by Piazzi, from nothing but a handful of observations made in the weeks before it disappeared in the glare of the morning sun.

The first point to realize, of course, is that the tiny arc of a few degrees, which Piazzi’s object appeared to describe against the background of the stars, was not the real path of the object in space. Rather, the positions recorded by Piazzi were the result of a rather complicated combination of motions. Indeed, the observed motion of any celestial object, as seen from the Earth, is compounded *chiefly* from the following three processes, or degrees of action:

1. The rotation of the Earth on its axis (uniform circular rotation, period one day). (Figure 2.3)
2. The motion of the Earth in its known Keplerian orbit around the sun (non-uniform motion on an ellipse, period one year). (Figure 2.4)
3. The motion of the planet in an unknown Keplerian

orbit (non-uniform motion, period unknown in the case of an elliptical orbit, or nonexistent in case of a parabolic or hyperbolic orbit). (Figure 2.5)

Thus, when we observe the planet, what we see is a kind of blend of all of these motions, mixed or “multiplied” together in a complex manner. Within any interval of time, however short, all three degrees of action are operating *together* to produce the apparent positions of the object. As it turns out, there is no simple way to “separate out” the three degrees of motion from the observations, because (as we shall see) the exact way the three motions are combined, depends on the parameters of the unknown orbit, which is exactly what we are trying to determine! So, *from a deductive standpoint*, we would seem to be caught in a hopeless, vicious circle. We shall get back to this point later.

Although the main features of the apparent motion are produced by the “triple product” of two elliptical motion and one circular motion, as just mentioned, several other processes are also operating, which have a comparatively slight, but nevertheless distinctly measurable effect on the apparent motions. In particular, for his *precise* forecast, Gauss had to take into account the following known effects:

4. The 25,700-year cycle known as the “precession of the equinoxes,” which reflects a slow shift in the Earth’s axis of rotation over the period of observation. (Figure 2.6) The angular change of the Earth’s axis in the course of a single year, causes a shift in the apparent positions of observed objects of the order of tens of seconds of arc (depending on their inclination to the celestial equator), which is much larger than the margin of

FIGURE 2.3. *Rotation of Earth (daily).*



FIGURE 2.4. *Orbit of Earth (yearly).*

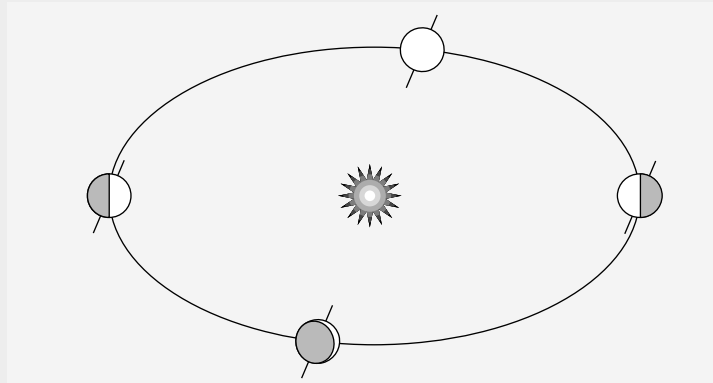

precision which Gauss required. (In Gauss's time astronomers routinely measured the apparent positions of objects in the sky to an accuracy of one second of arc, which corresponds to a 1,296,000th part of a full circle. Recall the standard angular measure: one full circle = 360 degrees; one degree = 60 minutes of arc; one minute of arc = 60 seconds of arc. Gauss is always working with parts-per-million accuracy, or better.)

5. The "nutations," which is a smaller periodic shift in the Earth's axis, superimposed on the 25,700-year precession, and chiefly connected with the orbit of the moon.
6. A slight shift of the apparent direction of a distant star or planet relative to the "true" one, called "aberration," due to the compound effect of the finite velocity of light and the velocity of the observer dur-

ing the time it takes the light to reach him.

7. The apparent positions of stars and planets, as seen from the Earth, are also significantly modified by the diffraction of light in the atmosphere, which bends the rays from the observed object, and shifts its apparent position to a greater or lesser degree, depending on its angle above the horizon. Gauss assumed that Piazzi, as an experienced astronomer, had already made the nec-

FIGURE 2.5. *Unknown orbit of "mystery planet" (period unknown).*

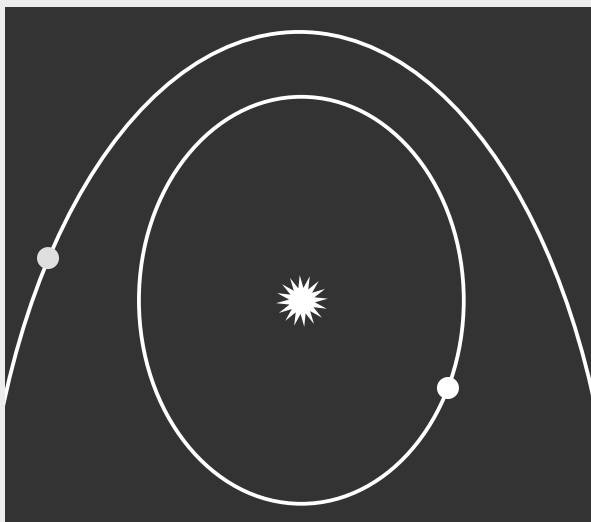
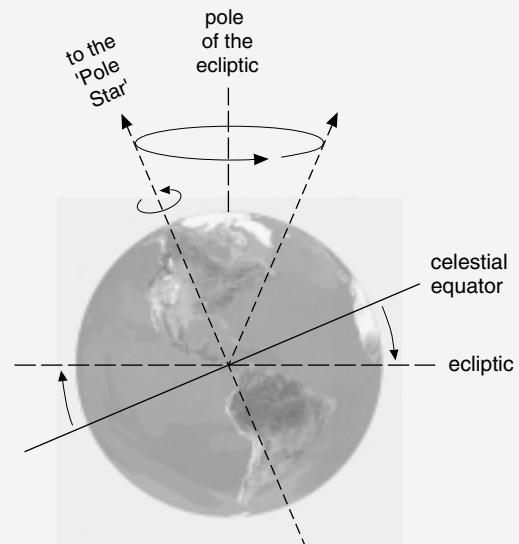

FIGURE 2.6. *Precession of the equinoxes (period 25,700 years). The "precession" appears as a gradual shift in the apparent positions of rising and setting stars on the horizon, as well as a shift in position of the celestial pole. This phenomenon arises because Earth's axis of rotation is not fixed in direction relative to its orbit and the stars, but rotates (precesses) very slowly around an imaginary axis called the "pole of the ecliptic," the direction perpendicular to the ecliptic plane (the plane of the Earth's orbit).*



essary corrections for diffraction in the reported observations. Nevertheless, Gauss naturally had to allow for a certain margin of error in Piazzi's observations, arising from the imprecision of optical instruments, in the determination of time, and other causes.

Finally, in addition to the exact times and observed positions of the object in the sky, Gauss also had to know the exact geographical position of Piazzi's observatory on the surface of the Earth.

## What Did Piazzi See?

Let us assume, for the moment, that the complications introduced by effects 4, 5, 6, and 7 above are of a relatively technical nature and do not touch upon what Gauss called "the nerve of my method." Focus first on obtaining some insight into the way the three main degrees of action 1, 2, and 3 combine to yield the observed positions.

For exploratory purposes, do something like the following experiment, which requires merely a large room and tables. (Figures 2.7 and 2.8) Set up one object to represent the sun, and arrange three other objects to represent three successive positions of the Earth in its orbit around the sun. This can be done in many variations, but a reasonable first selection of the "Earth" positions would be to place them on a circle of about two meters (about 6.5 feet) radius around the "sun," and about 23 centimeters (about 9 inches) apart—corresponding, let us say, to the positions on the Sundays of three successive weeks. Now arrange another three objects at a greater distance from the "sun," for example 5 meters (16 feet), and separated from each other by, say 6 and 7 centimeters. These positions need not be exactly on a circle, but only very roughly so. They represent hypothetical positions of Piazzi's object on the same three successive Sundays of observation.

For the purpose of the sightings we now wish to make, the best choice of "celestial objects" is to use small, bright-colored spheres or beads of diameter 1 cm or less, mounted at the end of thin wooden sticks which are fixed to wooden disks or other objects, the latter serving as

bases placed on the table, as shown in the photograph in Figure 2.7.

Now, sight from each of the Earth positions to the corresponding hypothetical positions of Piazzi's object, and beyond these to a blackboard or posters hung from an opposing wall. Imagine that wall to represent part of the celestial sphere, or "sphere of fixed stars." Mark the positions on the wall which lie on the lines of sight between the three pairs of positions of the Earth and Piazzi's object. Those three marks on the wall, represent the "data" of three of Piazzi's observations, in terms of the object's apparent position relative to the background of the fixed stars, assuming the observations were made on successive Sundays. Experimenting with different relative positions of the two in their orbits, we can see how the observational phenomenon of apparent retrograde motion and "looping" can come about (in fact, Piazzi observed a retrograde motion). (Figure 2.9) Experiment also with different arrangements of the spheres representing Piazzi's object, as might correspond to different orbits.

From this kind of exploration, we are struck by an enormous apparent ambiguity in the observations. What Piazzi saw in his telescope was only a very faint point of light, hardly distinguishable from a distant star except by its motion with respect to the fixed stars from day to day.



FIGURE 2.7. Author Bruce Director demonstrates Piazzi's sightings. The models on the table in the foreground represent the three different positions of the Earth. The models on the table in front of the board represent the three corresponding positions of Ceres. Marks 1, 2, and 3 on the board represent the sightings of Ceres, as seen from the corresponding positions of the Earth.

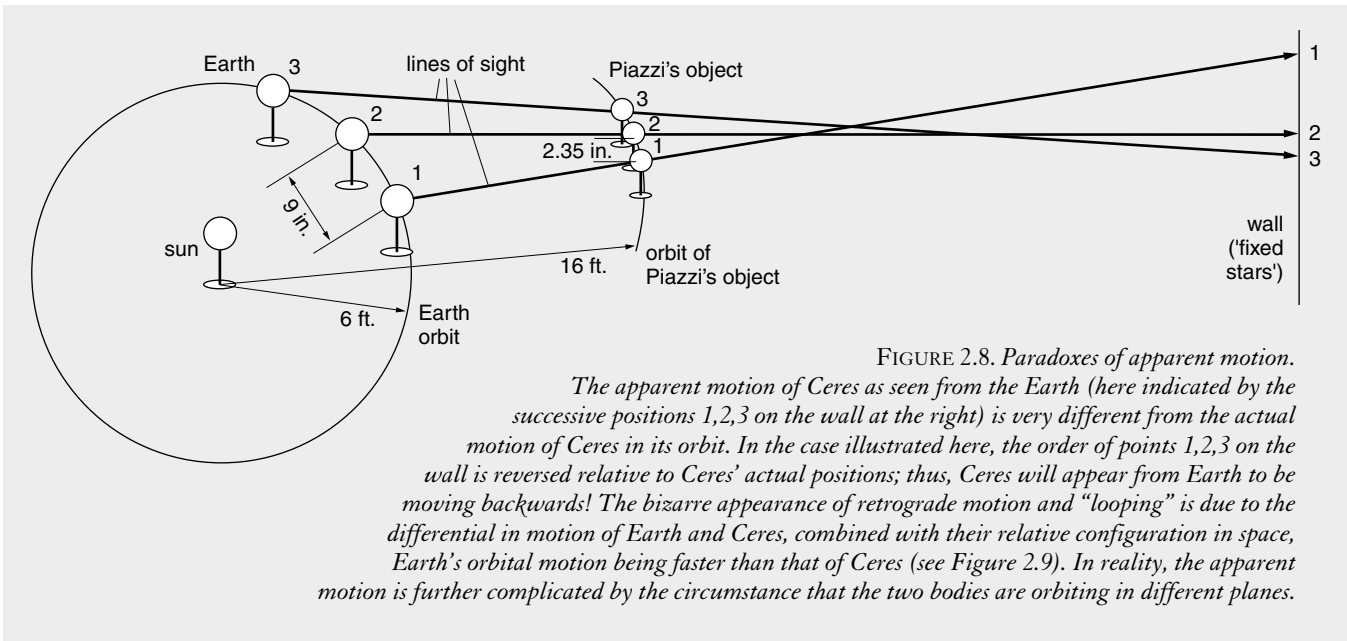

On the face of things, there would seem to be no way to know exactly how far away the object might be, nor in what exact direction it might be moving in space. Indeed, all we really have are three straight lines-of-sight, running from each of the three positions of the Earth to the corresponding marks on the wall. For all we know, each of the three positions of Piazzi's object might be located anywhere along the corresponding line-of-sight! We do know the *time intervals* between the positions we are looking at (in this case a period of one week), but how can that help us? Those times, in and of themselves, do

not even tell us how fast the object is really moving, since it might be closer or farther away, and moving more or less toward us or away from us.

Try as we will, there seems to be no way to determine the positions in space from the observations in a deductive fashion. But haven't we forgotten what Kepler taught us, about the primacy of the *orbit*, over the motions and positions?

Gauss didn't forget, and we shall discover his solution in the coming chapters.

—Jonathan Tennenbaum

FIGURE 2.9. *Star charts show apparent retrograde motion for the asteroids (a) Ceres, and (b) Pallas, during 1998.*

